

MUNDIAL

INDUSTRIAL PLUGS AND SOCKETS

Description: IP44 WALL PLUG 2P+E 220V 32A 6H

Reference:

02324

Characteristics:

Product type:	Low voltage wall socket
Current:	32A
Poles:	2P+E
Voltage:	200/250 V
Frecuency(Hz):	-
Time code:	6
Colour:	Blue
Weight (kg):	3,06
Dimensions:	
Materials:	Halogen-free plastic materials. Plastic parts: polyamide 6. Contacts: copper-zinc alloy
Packaging units:	10

Technical data:

Degree of protection:	IP44
Degree of protection remarks:	
Resistance to impact:	IK08
Glow wire resistance:	960 °C
Ball pressure test:	125 °C
Ambient temperature range:	-25 °C / +40 °C

Certifications and norms:

Directive:	2014/35/EU
Standards:	IEC 60309-1-2
Certificates:	



Codes:

EAN:	8431044023243
Customs tariff number:	85.36.69.90
ETIM 8.0:	EC001321

MUNDIAL

INDUSTRIAL PLUGS AND SOCKETS

Description: IP44 WALL PLUG 2P+E 220V 32A 6H

Reference: 02324

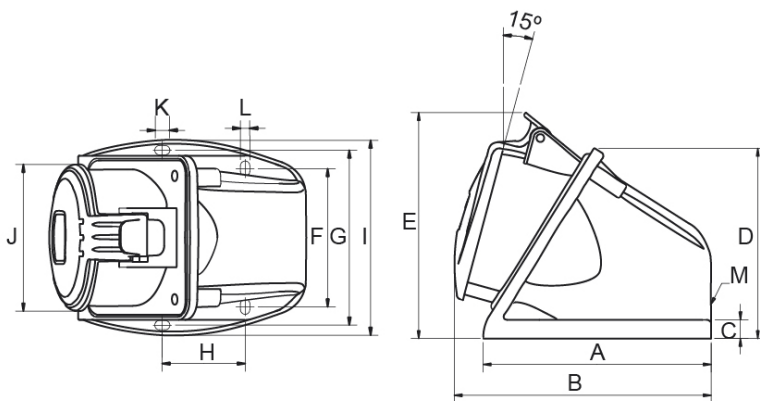

Dimensions:

Current	Poles	Dimensions												
		A	B	C	D	E	F	G	H	I	J	K	L	M
16 A	2P+E	100	109	10	88	98	53.6	76.6	40	87	55.5	8	5	M25x1.5
	3P+E	100	109	10	88	103	53.6	76.6	40	87	61.8	8	5	M25x1.5
	3P+N+E	118	127	10	99	117	71.6	90.6	43	101	70	8	5	M25x1.5
32A	2P+E	118	132	10	99	117	71.6	90.6	43	101	70	8	5	M25x1.5
	3P+E	118	132	10	99	117	71.6	90.6	43	101	70	8	5	M25x1.5
	3P+N+E	118	132	10	99	120	71.6	90.6	43	101	76.7	8	5	M25x1.5

Sustainability:

RoHS - REACH

Product end of life stage:

Product concerned in the WEEE regulations.

Supply:

Supplied in a single box per packaging multiple